

MERCHANT SHIPS CONVERSION FOR R.A.S.

BY

J. H. CHAPMAN, I.S.O., F.R.G.S., R.C.N.C.
(formerly of Ship Department)

One of the major military lessons of the Falklands war was the indispensable role of the merchant fleet in Britain's capability to conduct operations in defence of its more remote responsibilities. Without the back-up of vessels taken up from the Merchant Navy it would have been next to impossible to have transported thousands of men, vehicles, fuel, and equipment 8000 miles by sea and to have kept them supplied throughout the operation.

The Ships Taken Up From Trade were known collectively as STUFT ships. Use of similar ships had been a feature of World War I and World War II, the difference for the Falklands operation being the extreme urgency of the requisitioning and conversion.

The vast distances involved, together with the lack of bases on passage, made it essential to fit out almost all the STUFT ships—some 56—with Replenishment at Sea arrangements either for liquids or solids or frequently for both. This article has been written to record the experience of preparing the ships for replenishment from a headquarters viewpoint. The fitting of helicopter and Harrier landing platforms, new accommodation, and store-rooms is not addressed. The installation of aviation fuel systems is described elsewhere in this issue¹.

Drawings of ships proposed for requisitioning were often not available at Bath; at best only a General Arrangement could sometimes be obtained quickly. It was therefore necessary to inspect each ship at the earliest possible moment to decide on dockyard work necessary, and to provide sketches of work to be done and lists of materials required. This involved visiting ships so far afield as the Mediterranean and Germany, as well as at most major ports in the U.K.

The element of the inspection team specifically for RAS purposes consisted of one Ship Department Technical Officer and a RFA Deck Officer from DGST(N), the latter to advise on seamanship aspects and to liaise with the merchant vessel's master and officers on RAS procedures. On inspection, some ships were found not to be suitable after all.

The writer, at Bath, co-ordinated the work of the teams, approved the work package, and directed the flow of RAS information to the nominated dockyard or shipyard. Technical queries were answered and unique requirements hastened through the manufacturing process. Travel arrangements and expense advances had to be finalized or altered depending on the ever-fluid planning. One now amusing task was redirecting a lorry *en route* to Portland, inadvertently loaded with the wrong set of equipment, back to the R.N. Store Depot at Woolston. Dorset Constabulary were very useful.

At the inspections the basic information used was that given in Figs. 1 to 5. These give details of the abeam gear, the height of the connection points, and the swept area over the deck when carrying out a RAS. In some cases it was difficult to find structure of suitable strength to attach the highpoints (see FIG. 6) and recourse to additional structural stiffening was necessary. Where no such structure existed at the chosen RAS position a stump mast had to be designed, constructed, and fitted. Some spares of the LEANDER Class stump mast existed and six of these were used. In general the stump

masts had to be of larger diameter than LEANDER ones (8 inches instead of 6), because restrictions in available deck space prevented fully satisfactory spread of stays and hence increased crippling load. It should be noted that no attempt was made to fit STUFT ships so as to be able to replenish warships, with the exception of two tankers which had been previously selected and fitted for, but not with, the astern fuelling capability, of which more later.

The derrick and jackstay rigs are carried aboard RFAs and so the transfer of fuel and stores could only take place between the STUFT ship and a RFA. This is known as back-RASing. In determining the RAS position on the STUFT ship it was essential to ensure that it could marry up with at least one suitable RAS rig on each RFA without any problems of interaction between the ships when proceeding together.

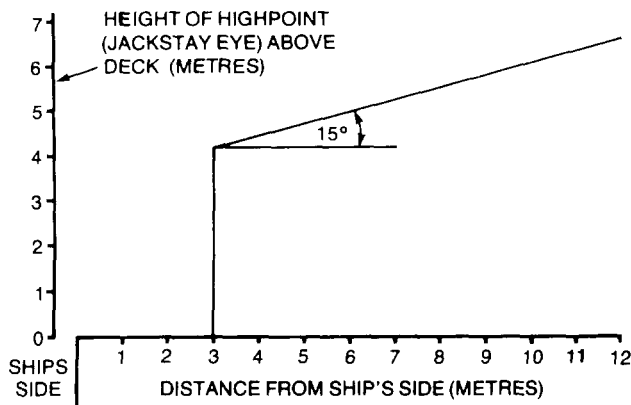

FIG. 1—REPLENISHMENT AT SEA HIGHPOINT: HEIGHT AND DISTANCE FROM DECK EDGE

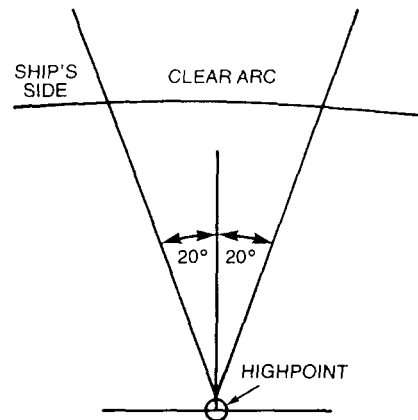

FIG. 2—CLEAR ARC FOR JACKSTAY

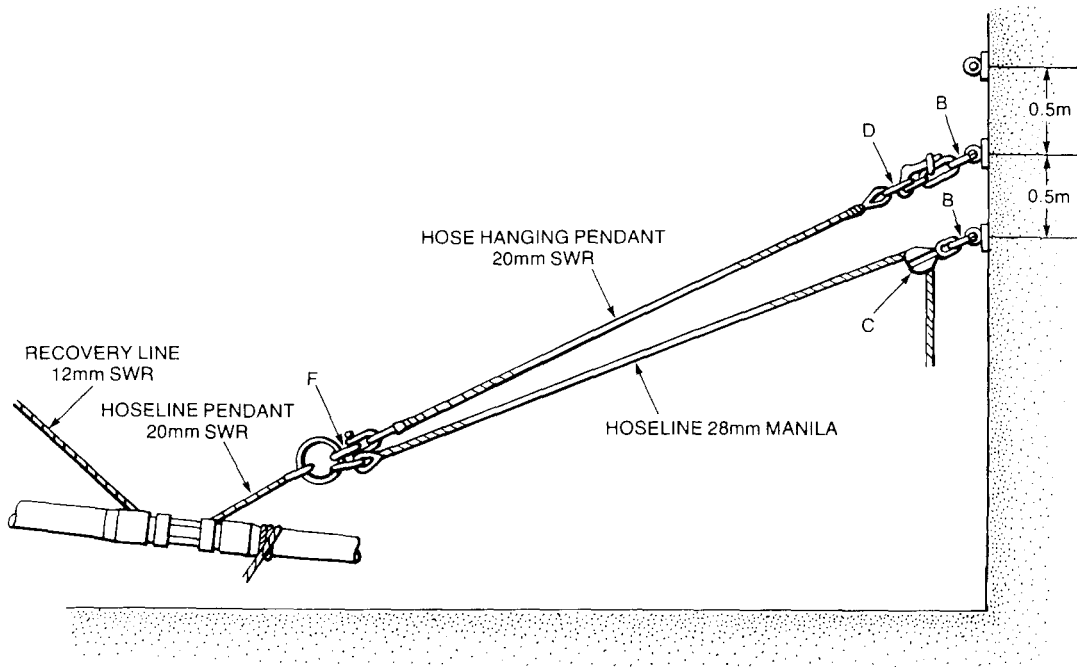

FIG. 3—DERRICK FUELLING ARRANGEMENTS

- Key: B—shackle
- C—snatch block
- D—link
- F—spring hook

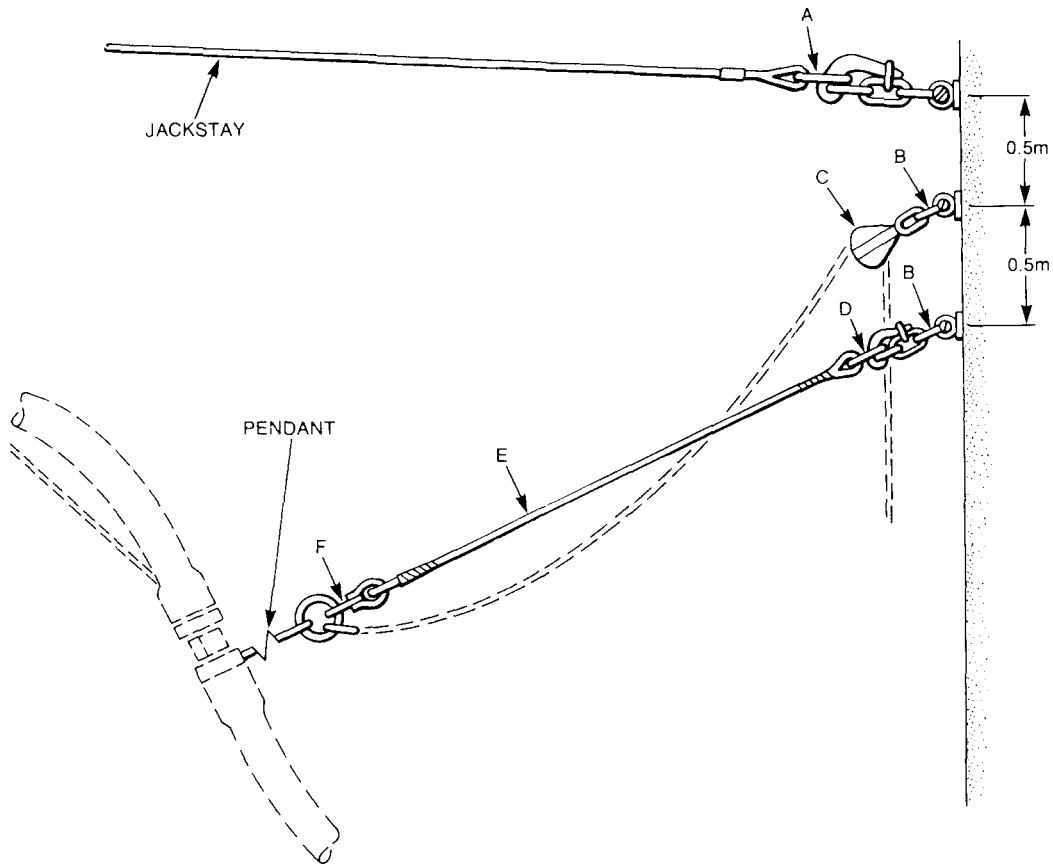

FIG. Fig. 4—JACKSTAY FUELING ARRANGEMENTS

- Key: A—NATO standard long link
 B—shackle
 C—snatch block
 D—link
 E—hose hanging pendant (20mm diam.)
 F—spring hook

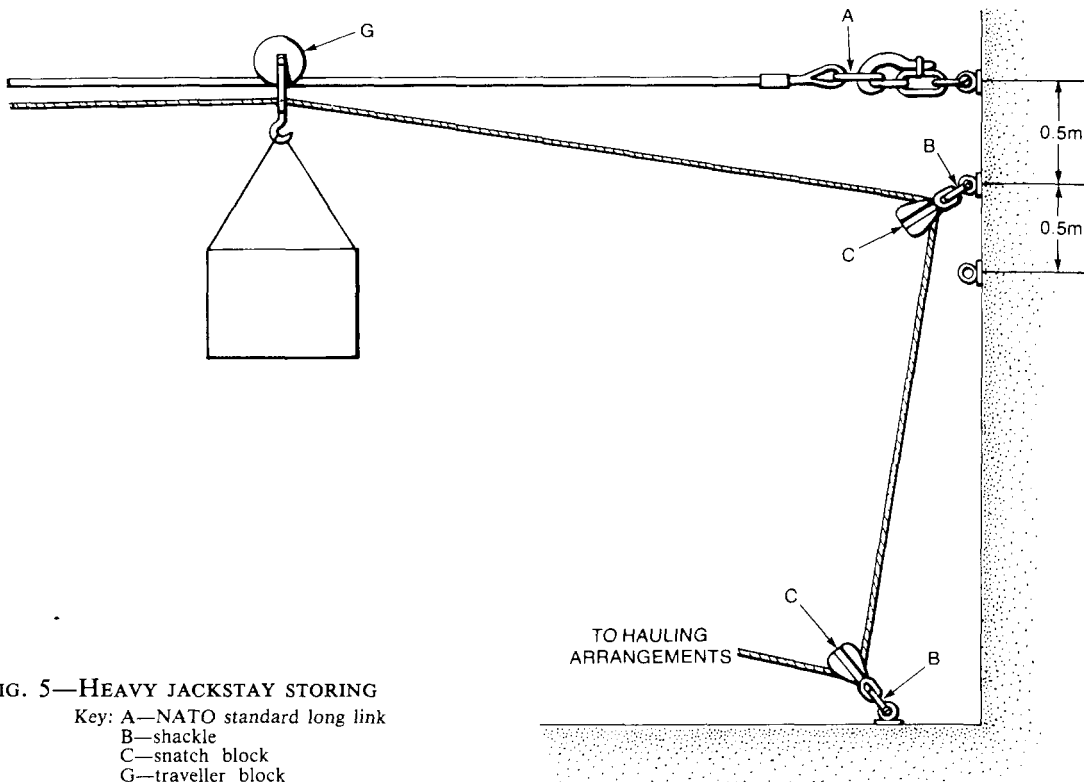

FIG. 5—HEAVY JACKSTAY STORING

- Key: A—NATO standard long link
 B—shackle
 C—snatch block
 G—traveller block

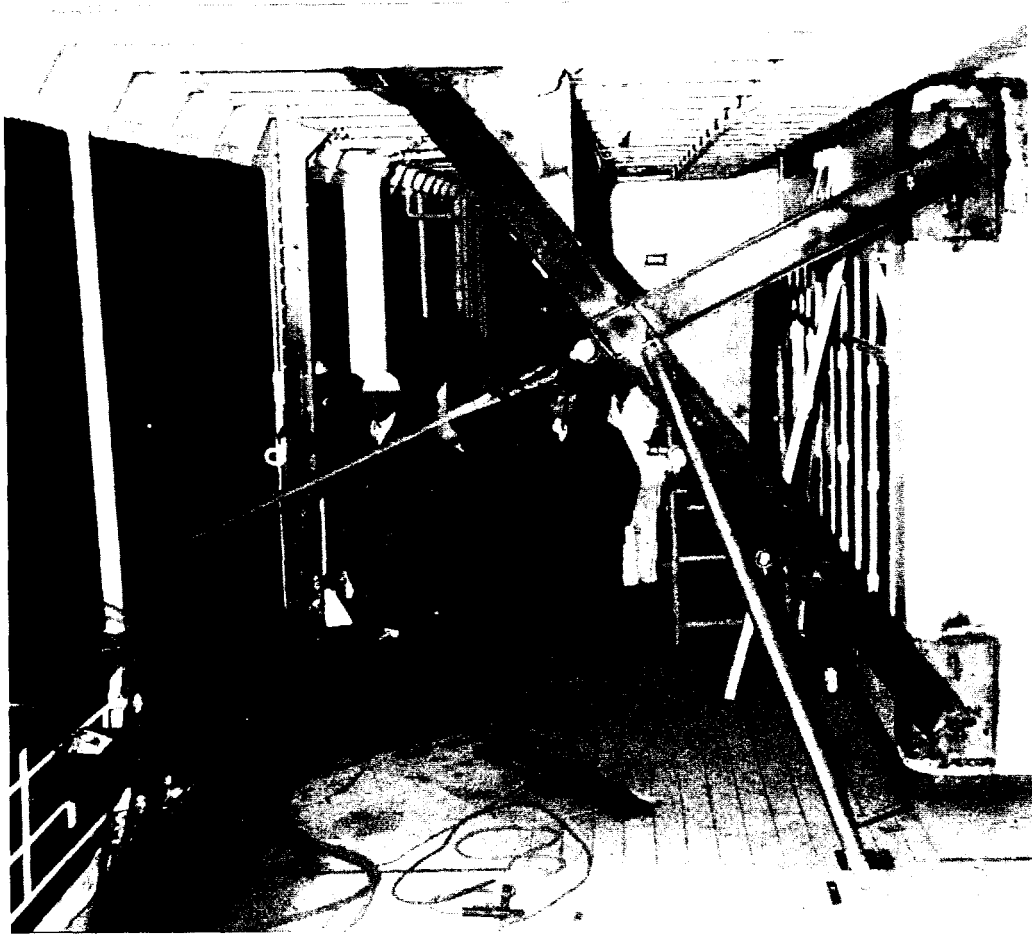

FIG. 6—TESTING A HIGH POINT IN S.S. 'UGANDA'

On the STUFT ships, leads from the reception point to a suitable winch for veering and hauling were sometimes tortuous, and sheaves and rollers had to be fitted to change the direction of the lead as required. Similarly, the fuel filling line on the STUFT ship was often remote from the RAS reception point. Merchant vessels fuel in harbour and connections are often close to the waterline, so fixed pipelines had to be laid to extend from the fuel transfer line deck connection to the reception point, to permit connection with the hose. Another problem area was the connection of the hose on the RAS rig to the various sizes of filling connections met with on the STUFT ships and suitable adaptors had, on occasions, to be made up with urgency.

The RAS equipment fitted consisted of basic seamanship equipment—e.g. slips, shackles, sheaves, pendants, etc.—and Naval Stores worked unceasingly to supply the items required from stocks that became ever lower as the Task Force ships brought themselves to full readiness. If stocks of a patternized article became exhausted, a suitable commercial alternative was sought but then a full check of its compatibility with the rest of the rig had to be made before it could be accepted.

Great difficulty was experienced in some instances in testing the highpoints after installation in the STUFT ship. Where testing was not possible, usually because of lack of available dockyard facilities, the welding or fixture was critically examined and accepted on an engineering judgement.

In the preparation of the Task Force the RAS Section of the Ship Department was ahead in one vital sector. The use of merchant tankers in war had already been foreseen in the NATO context and RAS arrangements had already been designed and procured for BP's RIVER Class tankers, giving

them abeam and astern fuelling capacity. The abeam fuelling arrangements were relatively simple and inexpensive and based on FIGS. 1 to 5. A number of sets of this equipment had already been manufactured and stored. The astern fuelling gear was more complex and only two ships, *British Tamar* and *British Esk*, had been fitted. After successful trials at sea the gear had been removed and stored. The astern fuelling gear took a considerable time to manufacture and, although eight RIVER Class tankers were chartered for the Falklands, only *British Tamar* and *British Esk* had the astern fuelling capacity fitted and so could refuel a warship directly, at sea, without the need of using an RFA. This rig was on one occasion successfully used to fuel a frigate with a force 10 gale blowing. The sea state was not reported.

One unusual conversion carried out, from the RAS point of view, was that of M.V. *St. Helena*, a ship 329 ft long of 3150 tons and normally used for passengers and cargo between Bristol and the island of St. Helena.

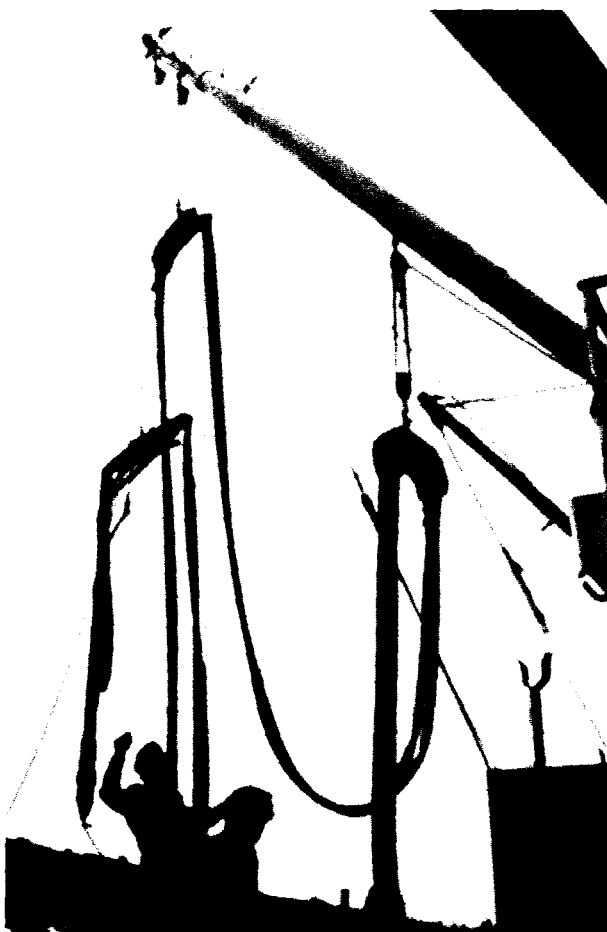

FIG. 7—ABEAM FUELLING RIG IN M.V. 'ST. HELENA'

Requisitioned as a minesweeper support ship, astern fuelling facilities and abeam facilities were both required. The minesweepers were served by a 3-inch fuelling line and it was found possible to convert a port derrick into a derrick fuel supply rig for the minesweepers (FIG. 7). In addition *St. Helena* could receive fuel or stores from any RFA rig on either beam. A further late requirement was to be able to fuel a minesweeper by astern rig, a concept which had been discarded as impossible at first inspection of the ship since she was different in configuration to *British Tamar* and *British Esk*. However it was found that space was available on the upper deck-edge passageway aft to fit a powered reel of the size necessary to reel and stow the foul weather allowance of 580 ft of 3-inch hose, provided a hose of the right specification and in one continuous length could be found. All enquiries seemed to lead to the U.S.A. as being the only source. By chance a sample hose of the right size and an acceptable specification had been received in the Ministry of Defence with a request that it be considered for a totally unrelated purpose. It was decided that, if the manufacturer could provide 580 ft of this hose in one length, we would use it. The hose was claimed to be wear-resistant, and the risk to the reliability of the rig of using an unproven hose was accepted. A simple hose repair kit was available. With U.K. industry enjoying a holiday week-end, it was ascertained that a hose of the length required was available at a works in the north of England. After inspection, the factory having been opened specially for the purpose, the hose was accepted and sent immediately to Portsmouth where the dockyard had already manufactured the reel (FIG. 8).

By chance a sample hose of the right size and an acceptable

Trials took place on passage to the Falklands and showed promising results. In the event the rig was not used operationally but it was available to give a heavy weather capability.

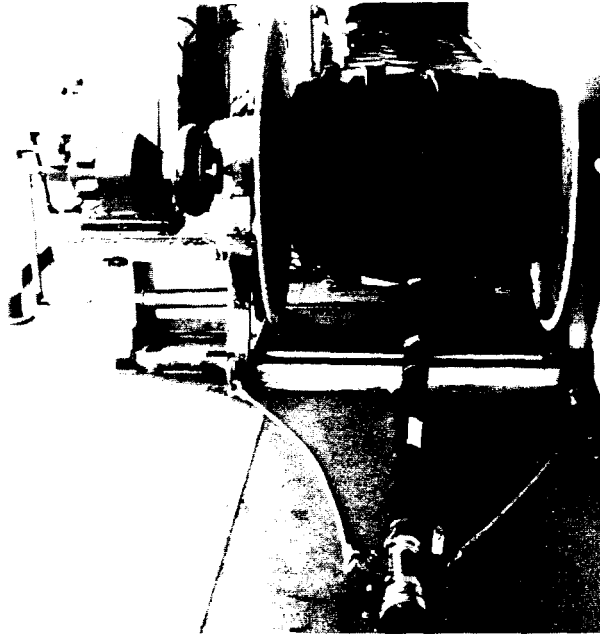

FIG. 8—ASTERN FUELLING RIG IN M.V. 'ST. HELENA'

Throughout the whole period of the preparation and support of the Task Force one could not but be impressed by the dedication shown by all concerned whether in headquarters, dockyards, industry, or in the ships. Jobs were completed often in a fraction of the time considered necessary in peacetime working; for example, one planned normally for 24 hours was completed in 4 hours late at night. A significant factor in achieving this remarkable productivity was that the man on the job relished being allowed to use his talents and expertise after a quick explanation of the work required.

Looking to the future, it would be of great value to the Navy if the relatively simple requirements for RAS could be built into British merchant ships under construction. Such a proposal could, of course, be applied also to other features, all of which cost money. I hope that the role of the Merchant Navy in the Falklands war will not be soon forgotten and that regular co-operation between the British Council of Shipping and MOD(N) will take place, leading to the incorporation of suitable facilities in the merchant fleet at build to prepare the vessels for use in war.

The opinions expressed in this article are those of the author and do not necessarily reflect the opinions of the Ministry of Defence to whom thanks are due for permission to publish.

References

1. Bowring, W. A. G.: Aviation fuel systems for S.T.U.F.T. ships; *Journal of Naval Engineering*, vol. 28, no. 1, Dec. 1983, pp. 43-46.